

FUJIFILM

instax Link WIDE™

Smartphone Printer

User's Guide (Full version)



Table of Contents

Before Use	3
Notes on Disposing of the Printer	3
Part Names.....	3
Attaching the Strap	4
Placing on the Stand.....	4
Installing the INSTAX LINK WIDE Smartphone App	4
Charging the Battery	4
Charging status indication with the LED.....	4
Loading/Unloading the INSTAX WIDE™ Instant Film Pack	5
Loading the Film Pack.....	5
Unloading a Used Film Pack	5
Turning on/off the Printer.....	6
Checking the Printer Status with the LED.....	6
Connecting Your Smartphone and Printer Together and Printing.....	6
When Establishing Connection for the First Time	6
When the Printer and Your Smartphone Are Already Connected.....	9
Specifications	10
Troubleshooting	10
IMPORTANT SAFETY NOTICE	11
Common Sense Printer Care.....	11
Bluetooth® Devices: Cautions.....	12

Before Use

Before using the printer, check the following.

Supplied Accessories

- Micro USB cable for charging (1)
- User's Guide (1)
- Limited Product Warranty (1)
- Stand (1)
- Strap (1)

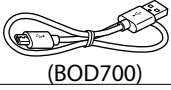

❗ The battery has not been fully charged at the factory. Be sure to charge the battery before using the printer.

Notes on Disposing of the Printer

A built-in lithium ion battery is used for this printer.

When you dispose of the printer, follow your local regulations and dispose of it properly.

For proper disposal in the United States at product end-of-life, please contact 1-800-800-3854 Option #1 INSTAX.

For proper disposal in Canada at product end-of-life, please contact 1-800-461-0416.

❗ Do not attempt to remove the built-in battery. Injury may result.

Read "IMPORTANT SAFETY NOTICE" (Page 11) for safety use.

Part Names

❗ Before using the printer for the first time, be sure to fully charge the battery.

Front

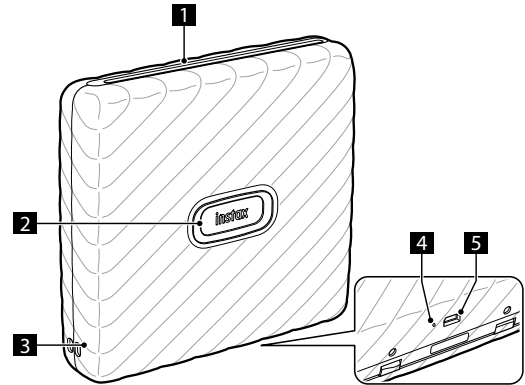

Rear

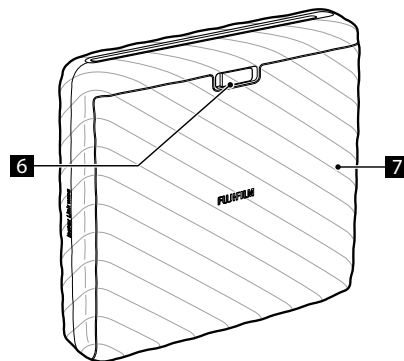

- ❶ Film ejection slot
- ❷ Power button/LED1
- ❸ Strap holes
- ❹ Reset button2
- ❺ Micro USB port
- ❻ Film door lock
- ❼ Film door

¹ For details on LED indication status, see pages 4 and 6.

² If the printer does not work properly, press the reset button to reset the printer.

Attaching the Strap

Attach the strap as illustrated below.

- ❗ Be sure the strap does not obstruct the film ejection slot.

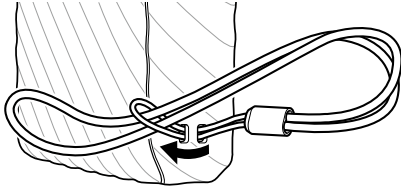

Placing on the Stand

The printer can be placed on the stand. When using the stand with the printer, be sure the film ejection slot is facing up.



Installing the INSTAX LINK WIDE Smartphone App

Please install the free INSTAX LINK WIDE Smartphone App on your Smartphone before using the printer. This is required for use of all available product features.

- If you are using an Android OS Smartphone, please search for the INSTAX LINK WIDE Smartphone App in the Google Play Store and install it.
*Requirements for Android OS Smartphones: Android Ver. 5.0 or higher with Google Play Store installed
- If you are using an iOS Smartphone, please search for the INSTAX LINK WIDE Smartphone App in the App Store and install it.
*Requirements for iOS Smartphones: iOS Ver. 10.0 or higher
- Depending on your Smartphone model, you may not be able to use the INSTAX LINK WIDE Smartphone App even if you have installed it and your Smartphone meets the above requirements.

Access the INSTAX LINK WIDE App download site by scanning the below QR codes for the latest information on system requirements.



iOS



Android OS

Charging the Battery

- ❗ Be sure to properly attach the Micro USB cable as indicated.

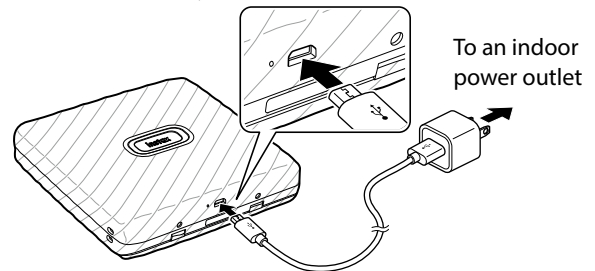

Note that USB AC adapter is not included, but is typically provided with your Smartphone or otherwise purchased separately.

Connect the printer with a USB AC adapter (not included with INSTAX LINK WIDE printer) using the supplied Micro USB cable, then connect the USB AC adapter to an indoor power outlet.

- You can print an image while charging is in progress.
- Charging time is approximately 80 to 120 minutes.

Charging status indication with the LED

Indication	Charging status
LED lights up in white	Not charging
LED flashes in white	Charging

Check the charging status with your Smartphone when connected with the free INSTAX LINK WIDE App.

For instructions on how to download the App, please see the Installing the INSTAX LINK WIDE Smartphone App section on this page.

* When the printer is turned off, the LED goes off after the charging is completed. When the printer is turned on and not connected with the App, the LED lights up in white after the charging is completed.

Charging from a PC:

- Connect the printer and PC directly using the supplied Micro USB cable. Insert the Micro USB cable into the Micro USB port of the printer and the USB port of the PC. Do not connect via a Micro USB hub or keyboard.
- If the PC goes into sleep mode while charging, charging is discontinued. To continue charging, exit sleep mode and then reconnect the Micro USB cable.
- The battery may not be able to charge depending on the specifications and settings or conditions of the PC.

Notes

- The battery has not been fully charged at the factory. Be sure to charge the battery before using the printer.
- The battery cannot be removed.
- For notes about the battery, see "Common Sense Printer Care". (p.11)

Loading/Unloading the INSTAX WIDE™ Instant Film Pack

Caution

Do not open the film door until you have used up the film; otherwise, the rest of the film will become exposed and turn white. The film can no longer be used.

- When you load the film pack, never press the two rectangular holes on the back of the film pack.
- Never use a film pack beyond its shelf life; otherwise, it may damage the printer.

Use FUJIFILM INSTAX WIDE instant print film only. The INSTAX SQUARE™ or INSTAX MINI™ instant print film cannot be used.

Notes on the INSTAX WIDE instant film pack

- Each FUJIFILM INSTAX WIDE instant film pack contains one black film protective cover and 10 film sheets.
- Do not remove the film pack from its inner bag until you are ready to load it into the printer.
- The film cover is ejected automatically from the printer after you close the film door.

For details, refer to the instructions and warnings on the package of FUJIFILM INSTAX WIDE instant print film.

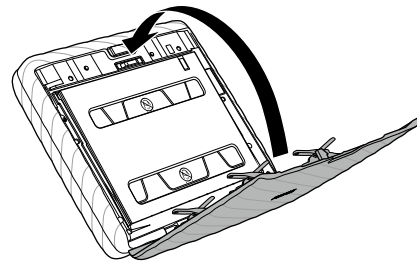

- 4 Remove the black film cover that is automatically ejected.

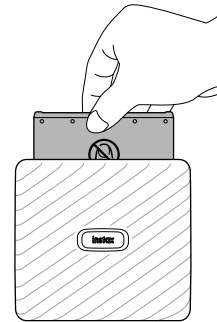

The INSTAX LINK WIDE Smartphone printer is designed for use with INSTAX WIDE instant print film only.

Loading the Film Pack

- 1 Slide and hold the film door lock and open the film door.

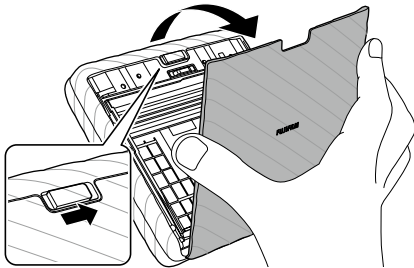

- 2 Insert film pack by aligning the yellow marks.

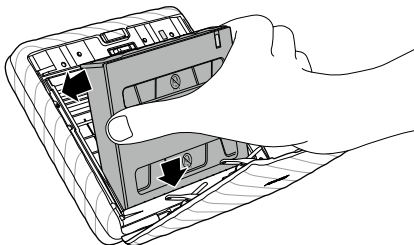

- 3 Close the film door.

Unloading a Used Film Pack

- 1 Slide the film door lock and open the film door.

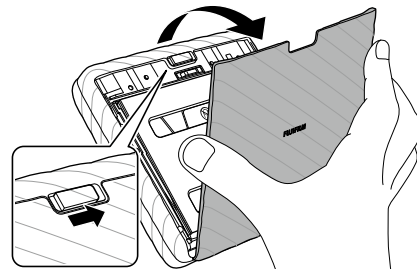

- 2 Grasp the rectangular holes on the film pack, then pull film pack out from the printer.

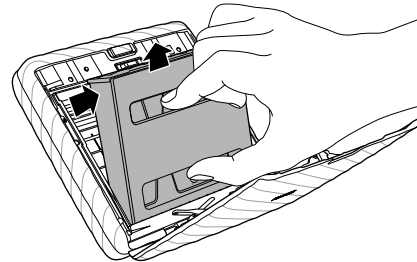

Turning on/off the Printer

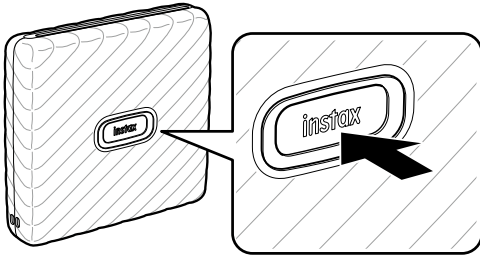

Press and hold the Power button for approximately 1 second to turn the printer on or off.

Turning the printer on lights up the LED.

If no operation occurs for a certain period of time, the printer turns off automatically.

Checking the Printer Status with the LED

You can check the printer status with the LED.

Color	LED status	Status
Blue	Flashing	Firmware is being updated
Yellow	Lights Up	Cannot be charged Film ejection error occurred
Yellow	Flashing	Attempted to print images when the film door was being opened Low battery state

Connecting Your Smartphone and Printer Together and Printing

With the functions of the IINSTAX WIDE Smartphone App, you can edit your favorite smartphone images before printing by adding text, applying filters, and much more! See Page 4 on how to install the Instax Wide Smartphone App or check out the following site: https://instax.com/link_wide/

When Establishing Connection for the First Time

- 1 Press and hold the Power button for approximately 1 second to turn the printer on.
The LED lights up.

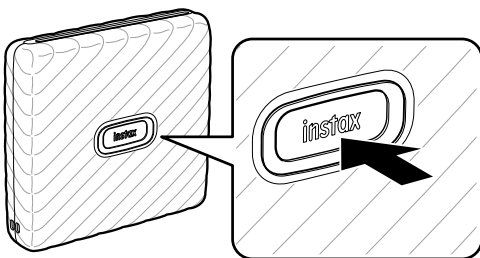

- 2 Start the downloaded INSTAX LINK WIDE Smartphone App.

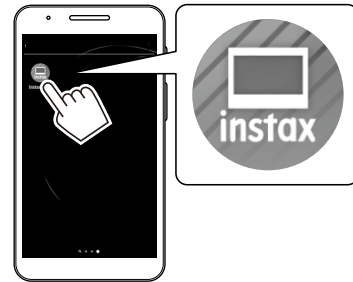

- 3 Click through the below pop-up windows to set up the printer.

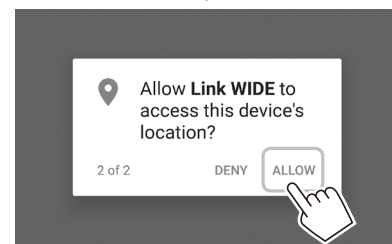
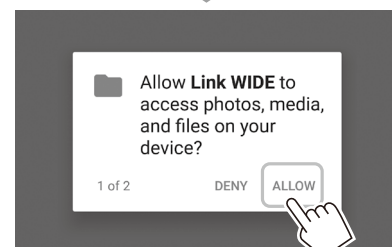
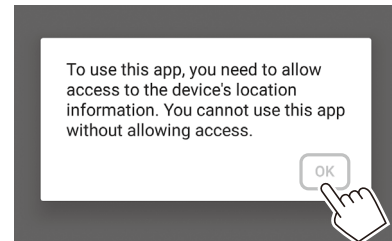
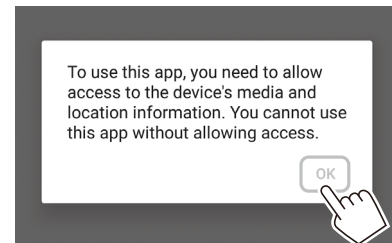

4 Read the Terms of Use, check the [Agree] box and tap the [AGREE] bar.

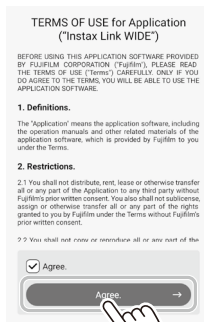

5 Quick instructions are displayed. Read the instructions and tap [Let's Play! →].

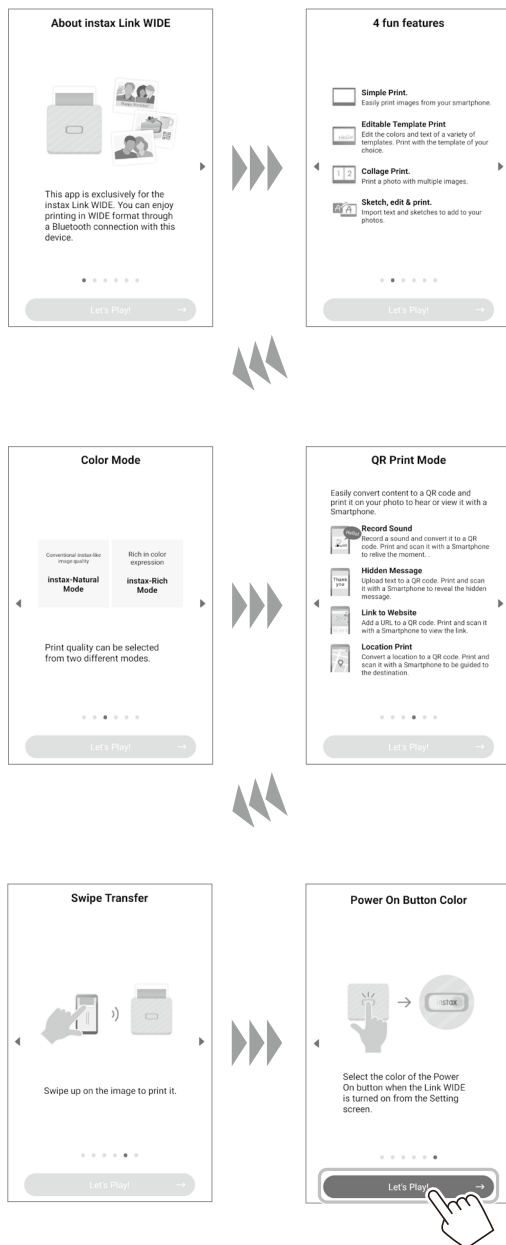

6 Set up the Bluetooth connection between your Smartphone and the printer. [Bluetooth connection] can also be set in the process of printing.

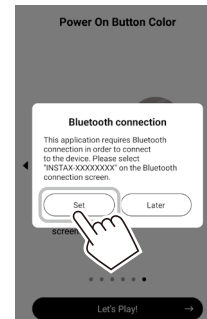

7 When a printer is detected, tap [Connect].
If multiple printers are detected, select the printer you would like to connect to from the list. Locate the printer's identifier (device name) on the bottom of the printer. Make sure the printer is on during this step. If not, turn the printer on by pressing and holding the Power button for 1 second.

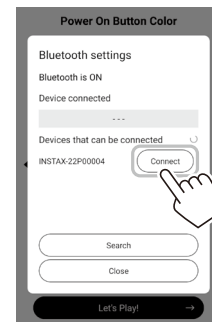

Note
If your Bluetooth settings are switched off, the following screen appears. Tapping [Please turn on Bluetooth] opens the Bluetooth settings screen. Put the Bluetooth settings on.

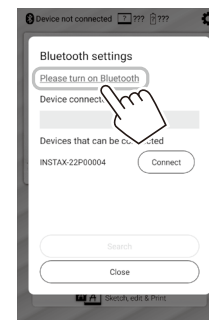

8 When the message is displayed, check the box and tap [PAIR].

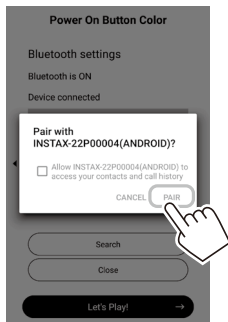

9 When a printer is connected, tap [Close].

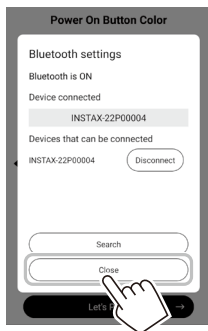

10 To select an image to print, click the Simple Print button on the INSTAX LINK WIDE Smartphone App home screen and select an image from your photo roll.

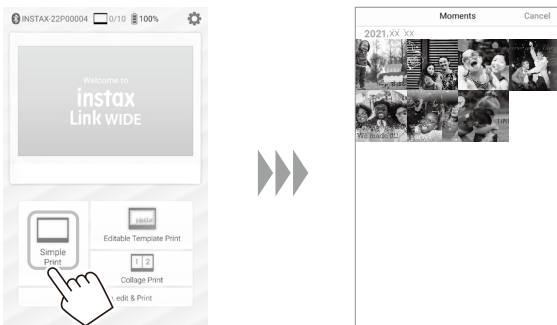

11 Tap or swipe the image up on the screen to print your image.

The printer starts printing.

You can also select the number of images to print during image transfer.

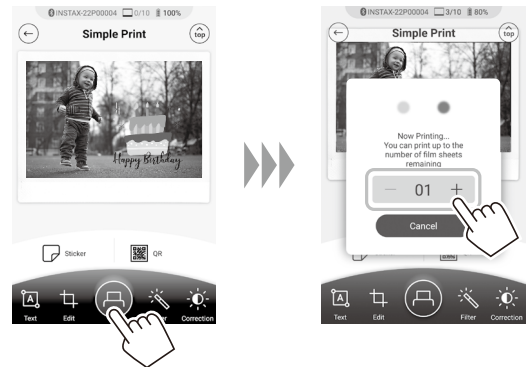

12 When the film has been ejected (the printer stops making a sound), hold the edge of the film, then take it out.

Confirm the number of images remaining in your INSTAX WIDE instant film pack on the Smartphone screen.

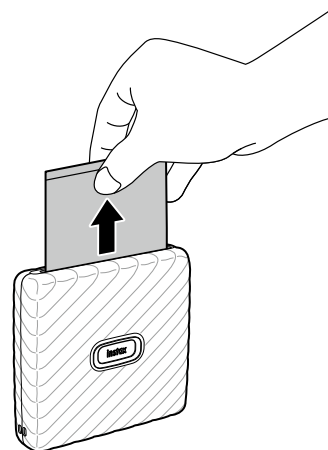

To edit your image, click on the below editing options on the bottom of the screen before printing.

	Enters text on images.
	Zooms up/down or rotates images.
	Applies a filter on images.
	Adjusts the brightness of images.

When the Printer and Your Smartphone Are Already Connected

- 1 Press and hold the Power button for approximately 1 second to turn the printer on.**
The LED lights up.

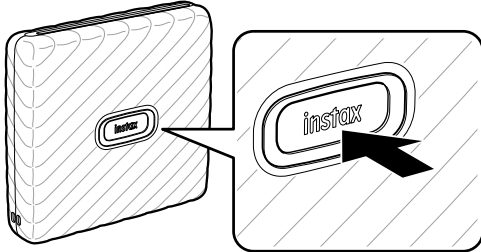

- 2 Start the downloaded INSTAX LINK WIDE Smartphone App.**



- 3 To select an image to print, click the Simple Print button on the INSTAX LINK WIDE Smartphone App home screen and select an image from your photo roll.**



To edit your image, click on the below editing options on the bottom of the screen before printing.

	Enters text on images.
	Zooms up/down or rotates images.
	Applies a filter on images.
	Adjusts the brightness of images.

- 4 Tap or swipe the image up on the screen to print your image.**

The printer starts printing.

You can also select the number of images to print during image transfer.



- 5 When the film has been ejected (the printer stops making a sound), hold the edge of the film, then take it out.**

Confirm the number of images remaining in your INSTAX LINK WIDE instant film pack on the Smartphone screen.

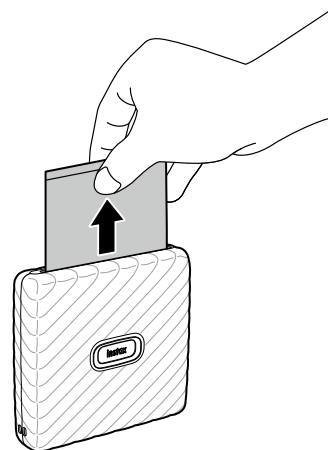

Specifications

Recording method	3-color exposure with OLED
Film used	FUJIFILM INSTAX WIDE instant film (sold separately)
Number of images	10 images/film pack
Image size	62 mm × 99 mm/2.4 in. × 3.9 in.
Supported image size	800 × 1260 dots
Printing resolution	12.5 dots/mm (318 dpi, 80 μm dot pitch)
Printing levels	256 levels per color (RGB)
Interface	Standard compliance: Bluetooth Ver. 4.2 (BLE)
Supported image format	JPEG, PNG, HEIF, DNG
Printing time	Image recording - photo output (fed out): Approximately 12 sec.
Approximate printing capacity	Approximately 100 prints (from full charge) * The number of prints depends on the usage conditions.
Power supply	Lithium ion battery (internal type: not removable)
Charging time	Approximately 80 to 120 minutes (Charging time depends on the temperature and battery remaining level)
Power consumption	Approximately 3 W
Operating environment	Temperature: +5°C to +40°C (+41°F to +104°F) Humidity: 20% to 80% (no condensation)
Main unit dimensions	139 mm × 127.5 mm × 33.7 mm/5.5 in. × 5 in. × 1.3 in.(excluding projecting parts)
Main unit weight	Approximately 340 g/12 oz (excluding film pack)
Supplied accessories	Micro USB cable (BOD700, Length: 30 cm/11.8 in.) Stand (1) Strap (1)

*The above specifications are subject to change.

Troubleshooting

Please check the following items before considering a problem to be a malfunction. If the problem persists even after taking action, please contact the Fujifilm service center for repair in your country or visit the website below.

Fujifilm website: <http://www.fujifilm.com/>

If the following problem occurs...

Problem	Possible causes and solutions
I cannot turn on the printer.	<ul style="list-style-type: none"> The battery may not be charged. Please charge the printer. You did not press the Power button long enough. Press and hold the Power button for approximately 1 second.
The battery loses its charge quickly.	If you use the printer in a very cold environment, the battery will drain quickly. Please keep the printer warm before printing.
The power cut off during use.	The battery level may be low. Please charge the printer.
Charging does not start.	Make sure that the USB power adapter plug is properly connected to the power outlet.
It takes too long to charge.	At low temperatures, charging may take some time.
Charging stops during charging.	Charge the battery in a temperature range of 5°C to 40°C (41°F to 104°F). If you cannot charge the printer in this range, contact your FUJIFILM dealer or support center.
The printer does not work properly.	<ul style="list-style-type: none"> There may be a temporary malfunction. Please press the reset button. If it still does not work properly, please contact our repair service center for repair. The battery may not be charged. Please charge the printer.
The film pack does not load or does not load smoothly.	<ul style="list-style-type: none"> Please use FUJIFILM INSTAX WIDE instant print film only (INSTAX SQUARE or INSTAX MINI instant print film cannot be used). Align the yellow mark on the film pack with the printer alignment mark (yellow) and load it.
The film does not unload.	<ul style="list-style-type: none"> The film may be misaligned due to shock such as vibration or dropping. Please load a new film pack. If the film is jammed, turn the printer off and turn it on again. If the problem persists, remove the jammed film and then load a new film pack.
Some or all of the finished prints are white.	Do not open the film door until the film is used up. If the film door is opened with film remaining, the film is exposed and the exposed area becomes white.
The print is uneven.	<ul style="list-style-type: none"> Do not shake, bend, fold or hold the print immediately after it is printed. Do not obstruct the film ejection slot.

IMPORTANT SAFETY NOTICE

This product has been designed with safety in mind, and to provide safe service when handled correctly and in accordance with the instructions in this User's Guide. It is important that both the product and the INSTAX WIDE instant film pack are handled properly and used only to print photos as instructed in this User's Guide and in the INSTAX WIDE instant film pack instructions. For your ease and safety, strictly follow the instructions in this User's Guide. Keep this User's Guide in a safe, convenient place for easy future reference as needed.

WARNING

This symbol indicates danger, which could result in product damage, injury or death. Follow the instructions indicated to avoid damage to the printer or injury.









WARNING

 If one of the following cases occur, immediately unplug the Micro USB cable, turn the printer off and refrain from any further use of the printer:

- The printer becomes hot, emits smoke, has a burnt smell, or otherwise seems abnormal.
- The printer is dropped into water, or foreign objects like water, sand, dirt or metal get inside the printer.

 The printer has a built-in battery. Do not subject it to heat, expose it to an open flame, drop it, or otherwise apply impact to it. Doing so may cause the printer to explode, resulting in injury.

WARNING

-  Never attempt to take this product apart. You may be injured.
-  All repairs should be handled solely by Fujifilm. Injury may result from attempts to self-assess or repair this printer.
-  If this product is dropped or damaged so that the inside is showing, do not touch it. Contact Fujifilm.
-  Do not touch any parts which are inside the film door. You may be injured.
-  Never get this product wet or handle it with wet hands. Doing so may result in electric shock and injury.
-  Promptly unplug the Micro USB cable once battery is fully charged.
-  Keep out of the reach of small children. This product could cause injury in the hands of a child.
-  Do not cover or wrap the printer or the AC power adapter in a cloth or blanket, or otherwise place the printer in the sun or an environment where heat may build up. This could distort the casing or cause a fire.



The "CE" mark certifies that this product satisfies the requirements of the EU (European Union) regarding safety, public health, environment and consumer protection. ("CE" is the abbreviation of Conformité Européenne.)

Common Sense Printer Care

■ Handling the Printer and Battery

- CAUTION - Do not expose to excessive heat such as sunshine, fire or the like, that can result in an explosion or the leakage of flammable liquid or gas during use, storage or transportation or disposal.
- CAUTION - Do not dispose of a battery into fire or a hot oven, or mechanically crush or cut a battery, that can result in an explosion.
- CAUTION - Do not subject to extremely low air pressure at high altitude that may result in an explosion or the leakage of flammable liquid or gas.

■ Printer Care

1. **Do not open the film door until you have used up the film; otherwise, the rest of the film is exposed and turns white. The film can no longer be used.**
2. Your printer is a precision instrument. Do not get it wet or drop it. Also, do not expose it to sand, dust or dirt.
3. Do not use cleaning products or solvents such as those with bleach or alcohol to remove dirt.
4. Keep the film chamber and printer interior clean to avoid damaging the film.
5. In hot weather, do not leave your printer in hot places such as in a car or on the beach. Do not leave it in damp places or places where weather exposure could result.
6. Moth repellent gas such as naphthalene may affect your printer and prints. Store your printer and photo prints in a place where exposure to harmful cleaning or other household elements will be avoided.
7. Note that the temperature range within which your printer can be used is 5°C to 40°C (41°F to 104°F).
8. Take great care to ensure that your prints do not violate copyright, image rights, privacy or other personal rights and do not offend public decency. Actions that violate the rights of others, are contrary to public decency or constitute a nuisance may be punishable by law or otherwise legally actionable.
9. This printer is designed for household use. It is not suitable for commercial printing which requires a large amount of printing.

■ Charging the Battery

The battery is not charged at shipment. Charge the battery completely before use.

Charge the battery using the supplied Micro USB cable. Charging times will increase at ambient temperatures below 10°C (50°F) or above 35°C (95°F). Do not attempt to charge the battery in environments with temperatures above 40°C (104°F); at temperatures below 5°C (41°F), the battery will not charge.

■ Battery Life

At normal temperatures, the battery can be recharged about 300 times. A noticeable decrease in the length of time the battery will hold a charge indicates that it has reached the end of its service life.

■ Caution: Handling the Battery

The battery and printer body may become warm to the touch after extended use. This is normal.

■ Certification marks acquired by the printer are located inside the film chamber.

■ Cautions During Printing



Do not shake the printer while printing.



Do not drop the printer while printing.



Do not cover the film ejection slot while printing.

■ INSTAX WIDE Instant Film and Print Care

See FUJIFILM INSTAX WIDE instant film pack use instructions. Follow all instructions for safe and proper use.

1. Keep the film in a cool place. Do not leave the film in a place where the temperature is extremely high (e.g., in a closed car) for many hours.
2. Do not puncture, tear, or cut INSTAX WIDE instant film. If film becomes damaged, do not use.
3. When you load a film pack, use the film as soon as possible.
4. If the film has been kept in a place where the temperature is extremely high or low, bring it to room temperature before loading or starting to print photos.
5. Be sure to use the film before the expiration or "Use Before" date.
6. Avoid airport checked luggage inspection and other strong X-ray illumination. The effect of fogging, etc. may appear on unused film. Carrying your printer and film onto an aircraft in your carry-on luggage is recommended. (Check with each airport for more information.)
7. Avoid strong light, and keep the developed prints in a cool and dry place.
8. Do not puncture or cut this film as it contains a small amount of caustic paste (high alkaline). Never let children or animals put the film into their mouth. Also pay attention so that the paste does not come into contact with skin or clothes.
9. If the paste inside the film comes into contact with skin or clothes, immediately wash off with plenty of water. If the paste comes into contact with the eyes or mouth, immediately wash the area with plenty of water and contact a doctor. Note that the alkaline inside the film remains active for about 10 minutes after the photo has been printed.

■ Cautions on Handling the Film and Prints

See below for film activities to be avoided.



Bluetooth® Devices: Cautions

IMPORTANT: Read the following notices before using the product's built-in Bluetooth transmitter.

■ Use only as part of a Bluetooth network.

FUJIFILM Corporation and its affiliates do not accept liability for damages resulting from unauthorized use. Do not use in applications requiring a high degree of reliability, for example in medical devices or other systems that may directly or indirectly impact human life. When using the device in computer and other systems that demand a greater degree of reliability than Bluetooth networks, be sure to take all necessary precautions to ensure safety and prevent malfunction.

■ Use only in the country in which the device was purchased.

This device conforms to regulations governing Bluetooth devices in the country in which it was purchased. Observe all location regulations when using the device. FUJIFILM Corporation and its affiliates do not accept liability for problems arising from use in other jurisdictions.

■ Wireless data (images) may be intercepted by third parties.

The security of data transmitted over wireless networks is not guaranteed. Do not use the device in locations subject to magnetic fields, static electricity, or radio interference.

■ Do not use the transmitter in the vicinity of microwave ovens or in other locations subject to magnetic fields, static electricity, or radio interference that may prevent reception of wireless signals. Mutual interference may occur when the transmitter is used in the vicinity of other wireless devices operating in the 2.4 GHz band.

■ The Bluetooth transmitter operates in the 2.4 GHz band. The maximum radio-frequency power is 9.10 mW.

■ This device operates on the same frequency as commercial, educational, and medical devices and wireless transmitters.

It also operates on the same frequency as licensed transmitters and special unlicensed low-voltage transmitters used in radio-frequency identification tracking systems for assembly lines and in other similar applications.

■ **To prevent interference with the above devices, observe the following precautions.**

Confirm that the radio-frequency identification transmitter is not in operation before using this device. If you notice that this device causes interference in low-voltage radio-frequency identification tracing systems, contact a Fujifilm representative.

■ **The following may be punishable by law:**

- Disassembly or modification of this device.
- Removal of device certification labels.

■ **Trademark Information**

The Bluetooth® word mark and logos are registered trademarks owned by the Bluetooth SIG, Inc., and any use of such marks by Fujifilm is under license.

For customers in the USA:

Contains IC : 7736B-03000007

Contains FCC ID : W2Z-03000008

FCC Statement

This device complies with part 15 of the FCC Rules. Operation is subject to the following two conditions: (1) This device may not cause harmful interference, and (2) this device must accept any interference received, including interference that may cause undesired operation.

For more information, access the website below.

https://instax.com/link_wide/en/spec/

CAUTION

This equipment has been tested and found to comply with the limits for a Class B digital device, pursuant to Part 15 of the FCC Rules. These limits are designed to provide reasonable protection against harmful interference in a residential installation. This equipment generates, uses, and can radiate radio frequency energy and, if not installed and used in accordance with the instructions, may cause harmful interference to radio communications. However, there is no guarantee that interference will not occur in a particular installation. If this equipment does cause harmful interference to radio or television, which can be determined by turning the equipment off and on, the user is encouraged to try to correct the interference by one or more of the following measures:

- Reorient or relocate the receiving antenna.
- Increase the separation between the equipment and receiver.
- Connect the equipment into an outlet on a circuit different from that to which the receiver is connected.
- Consult the dealer or an experienced radio/TV technician for help.

Changes or modifications not expressly approved by Fujifilm responsible for compliance could void the user's authority to operate the equipment.

This transmitter must not be co-located or operated in conjunction with any other antenna or transmitter.

The available scientific evidence does not show that any health problems are associated with using low power wireless devices. There is no proof, however, that these low power wireless devices are absolutely safe. Low power wireless devices emit low levels of radio frequency energy (RF) in the microwave range while being used. Whereas high levels of RF can produce health effects (by heating tissue), exposure of low-level RF that does not produce heating effects causes no known adverse health effects. Many studies of low-level RF exposures have not found any biological effects. Some studies have suggested that some biological effects might occur, but such findings have not been confirmed by additional research. This device has been tested and found to

comply with FCC radiation exposure limits set forth for an uncontrolled environment and meets the FCC radio frequency (RF) Exposure Guidelines.

Notes on the Grant

To comply with Part 15 of the FCC Rules, this product must be used with a Fujifilm-specified Micro USB cable.

For customers in Canada :

CAN ICES-3 (B)/NMB-3 (B)

This device contains licence-exempt transmitter(s)/receiver(s) that comply with Innovation, Science and Economic Development Canada's licence-exempt RSS(s). Operation is subject to the following two conditions:

1. This device may not cause interference.
2. This device must accept any interference, including interference that may cause undesired operation of the device.

The available scientific evidence does not show that any health problems are associated with using low power wireless devices. There is no proof, however, that these low power wireless devices are absolutely safe. Low power wireless devices emit low levels of radio frequency energy (RF) in the microwave range while being used. Whereas high levels of RF can produce health effects (by heating tissue), exposure of low-level RF that does not produce heating effects causes no known adverse health effects. Many studies of low-level RF exposures have not found any biological effects. Some studies have suggested that some biological effects might occur, but such findings have not been confirmed by additional research. This device has been tested and found to comply with ISED radiation exposure limits set forth for an uncontrolled environment and meets RSS-102 of the ISED radio frequency (RF) exposure rules.



Disposal of Electric and Electronic Equipment in Private Households
Disposal of used Electrical & Electronic Equipment
(Applicable in the European Union and other European countries with separate collection systems)

This symbol on the product, or in the manual and in the warranty, and/or on its packaging indicates that this product shall not be treated as household waste.

Instead it should be taken to an applicable collection point for the recycling of electrical and electronic equipment.

By ensuring this product is disposed of correctly, you will help prevent potential negative consequences to the environment and human health, which could otherwise be caused by inappropriate waste handling of this product.

The recycling of materials may help to conserve natural resources. For more detailed information about recycling of this product, please contact your local city recycling office, your household waste disposal service or the authorized FUJIFILM dealer from which you purchased the product.

For proper disposal in the United States at product end-of-life, please contact 1-800-800-3854 Option #1 INSTAX.

Information for Fujifilm in the United States

FUJIFILM North America Corp.
200 Summit Lake Drive
Valhalla, New York 10595, USA

Information for Fujifilm in Canada

FUJIFILM Canada Inc.
600 Suffolk Court, Mississauga, Ontario L5R 4G4, Canada

Independent JPEG Group (IJG) Licenses

The software used in the INSTAX LINK WIDE Smartphone Printer is based in part on the work of the Independent JPEG Group.

If you have any inquiries about this product, please contact a FUJIFILM authorized dealer, or access the website below.
<http://www.fujifilm.com/>

FUJIFILM

FUJIFILM Corporation

7-3, AKASAKA 9-CHOME, MINATO-KU, TOKYO 107-0052, JAPAN

FUJIFILM, INSTAX, INSTAX MINI, INSTAX SQUARE, INSTAX WIDE AND INSTAX LINK WIDE are trademarks of FUJIFILM Corporation and its affiliates.

© 2021 FUJIFILM Corporation. All rights reserved.